



# Dual SPDT Analog Switches with Over-Rail Signal Handling

## General Description

The MAX4850/MAX4850H/MAX4852/MAX4852H family of dual SPDT (single-pole/double-throw) switches operate from a single +2V to +5.5V supply and can handle signals greater than the supply rail. These switches feature low 3.5Ω or 3.5Ω/7Ω on-resistance with low on-capacitance, making them ideal for switching audio and data signals.

The MAX4850/MAX4850H are configured with two SPDT switches and feature two comparators for headphone detection or mute/send key functions. The MAX4852 has two SPDT switches with no comparators for low 1μA supply current.

For over-rail applications, these devices offer either the pass-through or high-impedance option. For the MAX4850/MAX4852, the signal (up to 5.5V) passes through the switch without distortion even when the positive supply rail is exceeded. For the MAX4850H/MAX4852H, the switch input becomes high impedance when the input signal exceeds the supply rail.

The MAX4850/MAX4850H/MAX4852/MAX4852H are available in the space-saving (3mm x 3mm), 16-pin TQFN package and operate over the extended temperature range of -40°C to +85°C.

## Applications

- USB Switching
- Audio-Signal Routing
- Cellular Phones
- Notebook Computers
- PDA's and Other Handheld Devices

## Features

- ◆ USB 2.0 Full Speed (12MB) and USB 1.1 Signal Switching Compliant
- ◆ Switch Signals Greater than V<sub>CC</sub>
- ◆ 0.1ns Differential Skew
- ◆ 3.5Ω/7Ω On-Resistance
- ◆ 135MHz -3dB Bandwidth
- ◆ +2V to +5.5V Supply Range
- ◆ 1.8V Logic Compatible
- ◆ Low Supply Current  
1μA (MAX4852)  
5μA (MAX4850)  
10μA (MAX4850H/MAX4852H)
- ◆ Available in a Space-Saving (3mm x 3mm), 16-Pin TQFN Package

## Ordering Information

PART	TEMP RANGE	PIN-PACKAGE	TOP MARK
MAX4850ETE	-40°C to +85°C	16 TQFN-EP*	ABU
MAX4850HETE	-40°C to +85°C	16 TQFN-EP*	ABV
MAX4852ETE	-40°C to +85°C	16 TQFN-EP*	ABZ
MAX4852HETE	-40°C to +85°C	16 TQFN-EP*	ACA

\*EP = Exposed paddle.

Pin Configurations and Selector Guide appear at end of data sheet.

## Block Diagrams/Truth Table

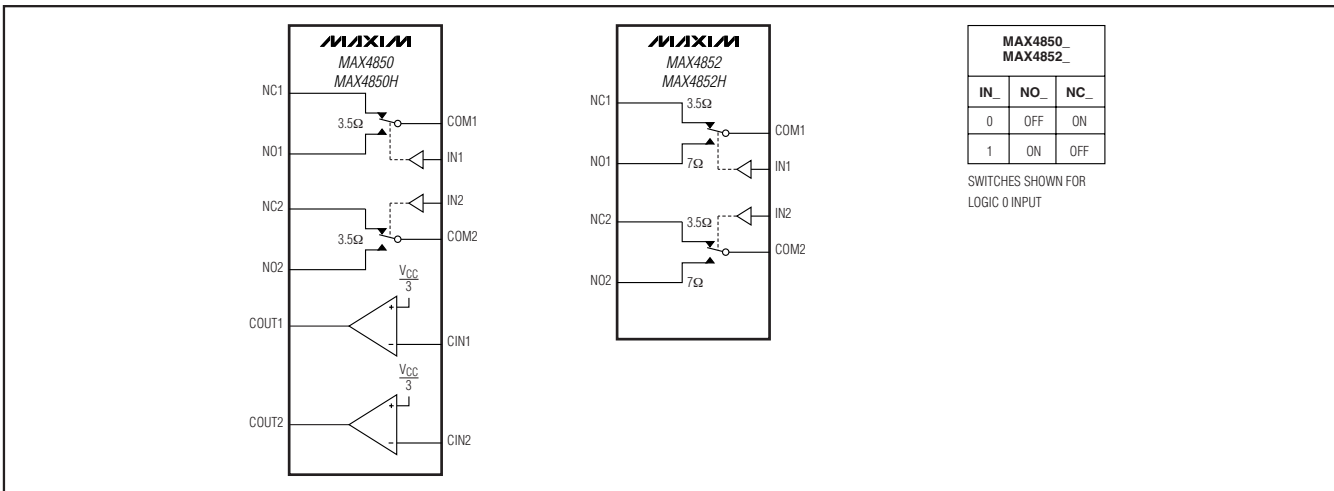

# Dual SPDT Analog Switches with Over-Rail Signal Handling

## ABSOLUTE MAXIMUM RATINGS

$V_{CC}$ , IN_, CIN_, COM_, NO_, NC_ to GND (Note 1).....	-0.3V to +6.0V
COU_T.....	-0.3V to ( $V_{CC}$ + 0.3V)
COU_T Continuous Current.....	±20mA
Closed Switch Continuous Current COM_, NO_, NC_ 3.5Ω Switch .....	±100mA
7Ω Switch .....	±50mA
Peak Current COM_, NO_, NC_ (pulsed at 1ms, 50% duty cycle) 3.5Ω Switch .....	±200mA
7Ω Switch .....	±100mA

Peak Current COM_, NO_, NC_ (pulsed at 1ms, 10% duty cycle) 3.5Ω Switch .....	±240mA
7Ω Switch .....	±120mA
Continuous Power Dissipation ( $T_A$ = +70°C) 16-Pin TQFN (derate 20.8mW/°C above +70°C).....	1667mW
Operating Temperature Range .....	-40°C to +85°C
Junction Temperature .....	+150°C
Storage Temperature Range .....	-65°C to +150°C
Lead Temperature (soldering, 10s) .....	+300°C

**Note 1:** Signals on IN, NO, NC, or COM below GND are clamped by internal diodes. Limit forward-diode current to maximum current rating.

Stresses beyond those listed under "Absolute Maximum Ratings" may cause permanent damage to the device. These are stress ratings only, and functional operation of the device at these or any other conditions beyond those indicated in the operational sections of the specifications is not implied. Exposure to absolute maximum rating conditions for extended periods may affect device reliability.

## ELECTRICAL CHARACTERISTICS

( $V_{CC}$  = +2.7V to +5.5V,  $T_A$  = -40°C to +85°C, unless otherwise noted. Typical values are at  $V_{CC}$  = +3.0V,  $T_A$  = +25°C, unless otherwise noted.) (Note 2)

PARAMETER	SYMBOL	CONDITIONS	MIN	TYP	MAX	UNITS
Supply Voltage	$V_{CC}$		2.0		5.5	V
Supply Current	$I_{CC}$	$V_{CC}$ = 5.5V, $V_{IN\_}$ = 0V or $V_{CC}$	MAX4850	5	10	μA
			MAX4850H/ MAX4852H	10	20	
			MAX4852		1	
<b>ANALOG SWITCH (3.5Ω Switch)</b>						
Analog Signal Range	$V_{NO\_}$ , $V_{NC\_}$ , $V_{COM\_}$		0		5.5	V
On-Resistance (Note 3)	$R_{ON}$	$V_{CC}$ = 3V, $I_{COM\_}$ = 10mA, $V_{NC\_}$ or $V_{NO\_}$ = 0 to 5.5V (MAX485_) or $V_{CC}$ (MAX485_H)	$T_A$ = +25°C	3.5	4.5	Ω
			$T_A$ = -40°C to +85°C		5	
On-Resistance Match Between Channels (Notes 3, 4)	$\Delta R_{ON}$	$V_{CC}$ = 3V, $I_{COM}$ = 10mA, $V_{NC\_}$ or $V_{NO\_}$ = 1.5V	$T_A$ = +25°C	0.1	0.2	Ω
			$T_A$ = -40°C to +85°C		0.25	
On-Resistance Flatness (Note 5)	$R_{FLAT}$	$V_{CC}$ = 3V, $I_{COM\_}$ = 10mA, $V_{NC\_}$ or $V_{NO\_}$ = 1V, 2V, 3V	$T_A$ = +25°C	1.2	1.8	Ω
			$T_A$ = -40°C to +85°C		2	
NO_/NC_ Off-Leakage Current	$I_{OFF}$	$V_{CC}$ = 5.5V, $V_{NC\_}$ or $V_{NO\_}$ = 1V or 4.5V, $V_{COM\_}$ = 4.5V or 1V	$T_A$ = +25°C	-2	+2	nA
			$T_A$ = -40°C to +85°C	-10	+10	
COM_ On-Leakage Current	$I_{ON}$	$V_{CC}$ = 5.5V; $V_{NC\_}$ or $V_{NO\_}$ = 1V, 4.5V, or floating; $V_{COM\_}$ = 1V, 4.5V, or floating	$T_A$ = +25°C	-2	+2	nA
			$T_A$ = -40°C to +85°C	-12.5	+12.5	
-3dB Bandwidth	BW	Signal = 0dBm, $R_L$ = 50Ω, $C_L$ = 5pF (Figure 5)		100		MHz
NO_/NC_ Off-Capacitance	$C_{OFF}$	f = 1MHz (Figure 6)		20		pF

# Dual SPDT Analog Switches with Over-Rail Signal Handling

MAX4850/MAX4850H/MAX4852/MAX4852H

## ELECTRICAL CHARACTERISTICS (continued)

( $V_{CC} = +2.7V$  to  $+5.5V$ ,  $T_A = -40^\circ C$  to  $+85^\circ C$ , unless otherwise noted. Typical values are at  $V_{CC} = +3.0V$ ,  $T_A = +25^\circ C$ , unless otherwise noted.) (Note 2)

PARAMETER	SYMBOL	CONDITIONS	MIN	TYP	MAX	UNITS
COM On-Capacitance	$C_{ON}$	$f = 1MHz$ (Figure 6)		60		pF
<b>ANALOG SWITCH (7<math>\Omega</math> Switch)</b>						
Analog Signal Range	$V_{NO\_}$ , $V_{NC\_}$ , $V_{COM\_}$		0		5.5	V
On-Resistance	$R_{ON}$	$V_{CC} = 3V$ , $I_{COM\_} = 10mA$ , $V_{NC\_}$ or $V_{NO\_} = 0$ to $5.5V$ (MAX4852) or $V_{CC}$ (MAX4852H)	$T_A = +25^\circ C$	7	9	$\Omega$
			$T_A = -40^\circ C$ to $+85^\circ C$		10	
On-Resistance Match Between Channels (Notes 3, 4)	$\Delta R_{ON}$	$V_{CC} = 3V$ , $I_{COM\_} = 10mA$ , $V_{NC\_}$ or $V_{NO\_} = 1.5V$	$T_A = +25^\circ C$	0.2	0.4	$\Omega$
			$T_A = -40^\circ C$ to $+85^\circ C$		0.5	
On-Resistance Flatness (Note 5)	$R_{FLAT}$	$V_{CC} = 3V$ , $I_{COM\_} = 10mA$ , $V_{NC\_}$ or $V_{NO\_} = 1V, 2V, 3V$	$T_A = +25^\circ C$	2.5	3.75	$\Omega$
			$T_A = -40^\circ C$ to $+85^\circ C$		4.0	
NO_/NC_ Off-Leakage Current	$I_{OFF}$	$V_{CC} = 5.5V$ , $V_{NC\_}$ or $V_{NO\_} = 1V$ or $4.5V$ , $V_{COM\_} = 4.5V$ or $1V$	$T_A = +25^\circ C$	-2	+2	nA
			$T_A = -40^\circ C$ to $+85^\circ C$	-10	+10	
COM_ On-Leakage Current	$I_{ON}$	$V_{CC} = 5.5V$ ; $V_{NC\_}$ or $V_{NO\_} = 1V, 4.5V$ , or floating; $V_{COM\_} = 1V, 4.5V$ , or floating	$T_A = +25^\circ C$	-2	+2	nA
			$T_A = -40^\circ C$ to $+85^\circ C$	-12.5	+12.5	
-3dB Bandwidth	BW	Signal = 0dBm, $R_L = 50\Omega$ , $C_L = 5pF$ (Figure 5)		135		MHz
NO_/NC_ Off-Capacitance	$C_{OFF}$	$f = 1MHz$ (Figure 6)		12		pF
COM On-Capacitance	$C_{ON}$	$f = 1MHz$ (Figure 6)		50		pF
<b>DYNAMIC CHARACTERISTICS</b>						
Signal Over-Rail to High-Z Switching Time	$t_{HIZ}$	MAX4850H/MAX4852H, $V_{NO\_}$ or $V_{NC\_} = V_{CC}$ to $(V_{CC} + 0.5V)$ , $V_{CC} < 5V$ (Figure 1)		0.5	1	$\mu s$
High-Z to Low-Z Switching Time	$t_{HIZB}$	MAX4850H/MAX4852H, $V_{NO\_}$ or $V_{NC\_} = (V_{CC} + 0.5V)$ to $V_{CC}$ , $V_{CC} < 5V$ (Figure 1)		0.5	1	$\mu s$
Skew (Note 3)	$t_{SKEW}$	$R_S = 39\Omega$ , $C_L = 50pF$ (Figure 2)		0.1	1	ns
Propagation Delay (Note 3)	$t_{PD}$	$R_S = 39\Omega$ , $C_L = 50pF$ (Figure 2)		0.9	2	ns
Turn-On Time	$t_{ON}$	$V_{CC} = 3V$ , $V_{NO\_}$ or $V_{NC\_} = 1.5V$ , $R_L = 300\Omega$ , $C_L = 50pF$ (Figure 1)	$T_A = +25^\circ C$	40	60	ns
			$T_A = -40^\circ C$ to $+85^\circ C$		100	
Turn-Off Time	$t_{OFF}$	$V_{CC} = 3V$ , $V_{NO\_}$ or $V_{NC\_} = 1.5V$ , $R_L = 300\Omega$ , $C_L = 50pF$ (Figure 1)	$T_A = +25^\circ C$	30	40	ns
			$T_A = -40^\circ C$ to $+85^\circ C$		60	

# Dual SPDT Analog Switches with Over-Rail Signal Handling

## ELECTRICAL CHARACTERISTICS (continued)

( $V_{CC} = +2.7V$  to  $+5.5V$ ,  $T_A = -40^{\circ}C$  to  $+85^{\circ}C$ , unless otherwise noted. Typical values are at  $V_{CC} = +3.0V$ ,  $T_A = +25^{\circ}C$ , unless otherwise noted.) (Note 2)

PARAMETER	SYMBOL	CONDITIONS	MIN	TYP	MAX	UNITS
Break-Before-Make Time Delay (Note 3)	$t_D$	$V_{CC} = 3V$ , $V_{NO\_}$ or $V_{NC\_} = 1.5V$ , $R_L = 300\Omega$ , $C_L = 50pF$ (Figure 3)	$T_A = +25^{\circ}C$	15		ns
			$T_A = -40^{\circ}C$ to $+85^{\circ}C$	2		
Charge Injection	Q	$V_{COM\_} = 1.5V$ , $R_S = 0\Omega$ , $C_L = 1nF$ (Figure 4)	8		pC	
Off-Isolation (Note 6)	$V_{ISO}$	$f = 100kHz$ , $V_{COM\_} = 1V_{RMS}$ , $R_L = 50\Omega$ , $C_L = 5pF$ (Figure 5)	-80		dB	
Crosstalk	$V_{CT}$	$f = 1MHz$ , $V_{COM\_} = 1V_{RMS}$ , $R_L = 50\Omega$ , $C_L = 5pF$ (Figure 5)	-95		dB	
Total Harmonic Distortion	THD	$f = 20Hz$ to $20kHz$ , $V_{COM\_} = 1V + 2V_{P-P}$ , $R_L = 600\Omega$	0.04		%	
<b>DIGITAL I/O (IN_)</b>						
Input-Logic High Voltage	$V_{IH}$	$V_{CC} = 2V$ to $3.6V$	1.4		V	
		$V_{CC} = 3.6V$ to $5.5V$	1.8			
Input-Logic Low Voltage	$V_{IL}$	$V_{CC} = 2V$ to $3.6V$	0.5		V	
		$V_{CC} = 3.6V$ to $5.5V$	0.8			
Input Leakage Current	$I_{IN}$	$V_{IN\_} = 0$ or $5.5V$	-0.5	+0.5		$\mu A$
<b>COMPARATOR</b>						
Comparator Range			0	5.5		V
Comparator Threshold	$V_{TH}$	$V_{CC} = 2V$ to $5.5V$ , falling input	$0.3 \times V_{CC}$	$0.33 \times V_{CC}$	$0.36 \times V_{CC}$	V
Comparator Hysteresis		$V_{CC} = 2V$ to $5.5V$	50		mV	
Comparator Output High Voltage		$I_{SOURCE} = 1mA$	$V_{CC} - 0.4V$		V	
Comparator Output Low Voltage		$I_{SINK} = 1mA$	0.4		V	
Comparator Switching Time		Rising input (Figure 7)	2.5		$\mu s$	
		Falling input (Figure 7)	0.5			

**Note 2:** Specifications are 100% tested at  $T_A = +85^{\circ}C$  only, and guaranteed by design and characterization over the specified temperature range.

**Note 3:** Guaranteed by design and characterization; not production tested.

**Note 4:**  $\Delta R_{ON} = R_{ON(MAX)} - R_{ON(MIN)}$ .

**Note 5:** Flatness is defined as the difference between the maximum and minimum value of on-resistance as measured over the specified analog signal ranges.

**Note 6:** Off-isolation =  $20\log_{10}(V_{COM\_} / V_{NO\_})$ ,  $V_{COM\_}$  = output,  $V_{NO\_}$  = input to off switch.

# Dual SPDT Analog Switches with Over-Rail Signal Handling

## Typical Operating Characteristics

( $V_{CC} = 3.0V$ ,  $T_A = +25^\circ C$ , unless otherwise noted.)

MAX4850/MAX4850H/MAX4852/MAX4852H

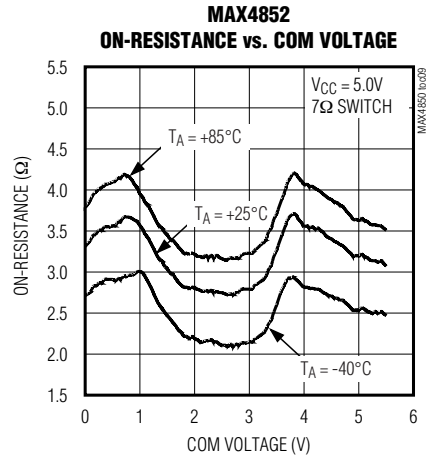
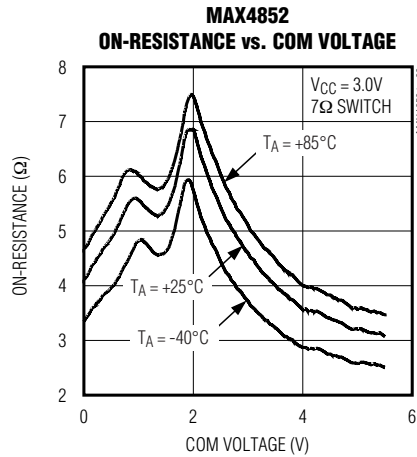
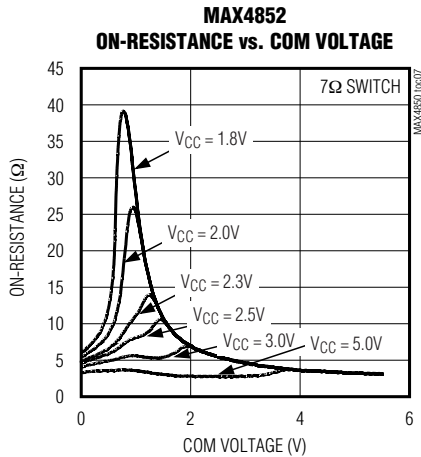
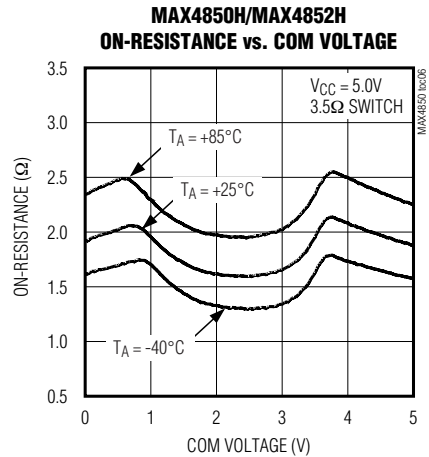
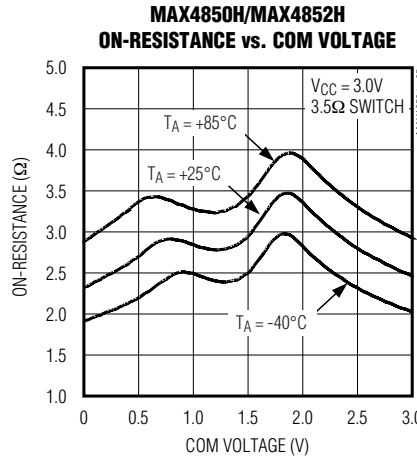
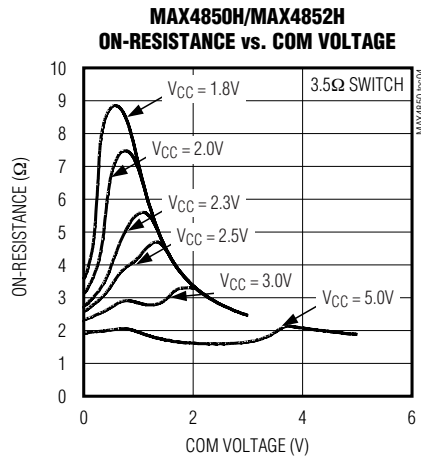
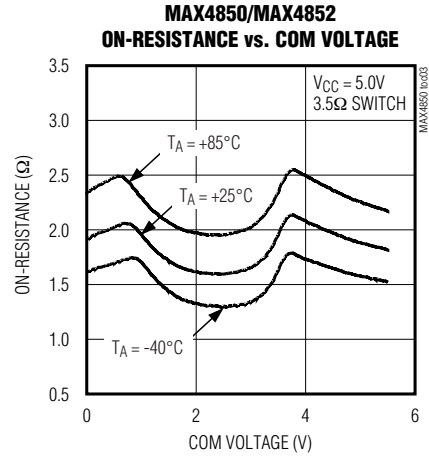
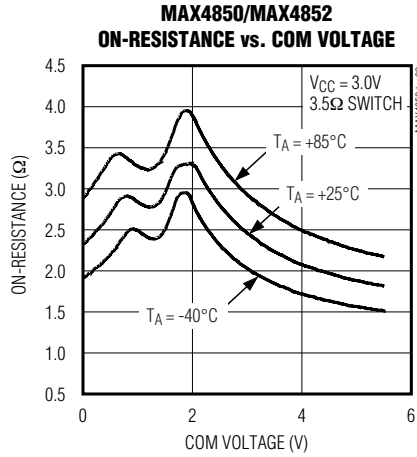
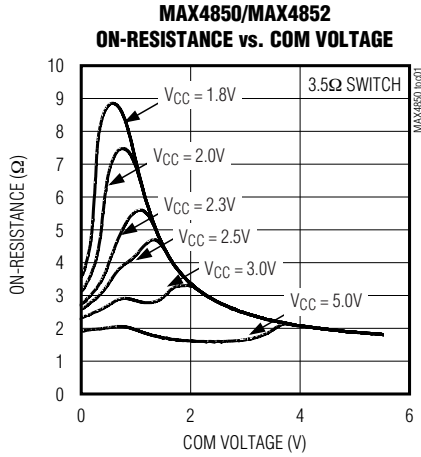

# Dual SPDT Analog Switches with Over-Rail Signal Handling

## Typical Operating Characteristics (continued)

( $V_{CC} = 3.0V$ ,  $T_A = +25^\circ C$ , unless otherwise noted.)

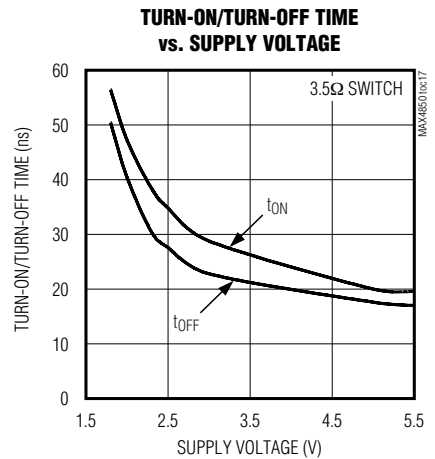
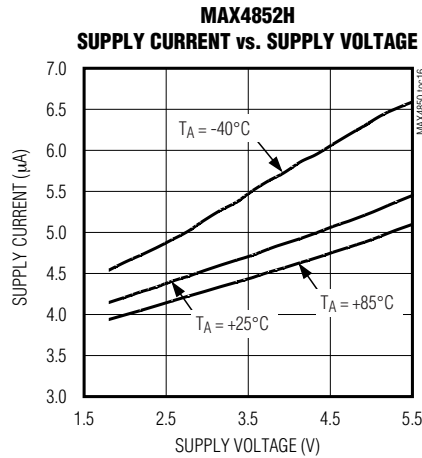
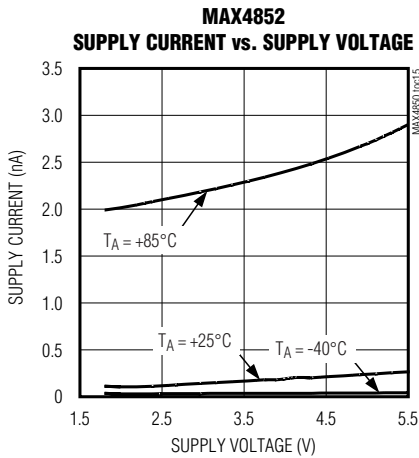
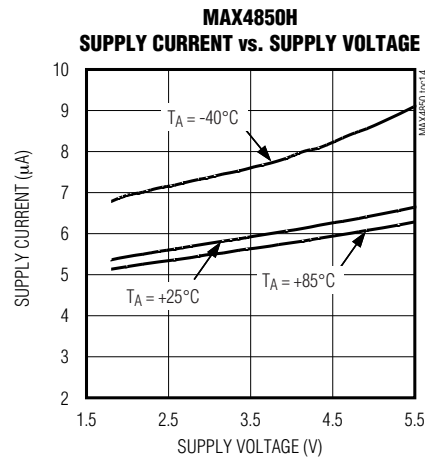
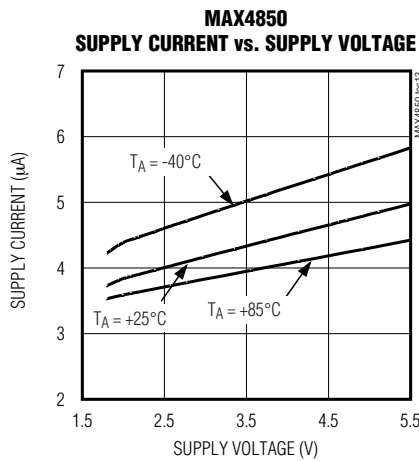
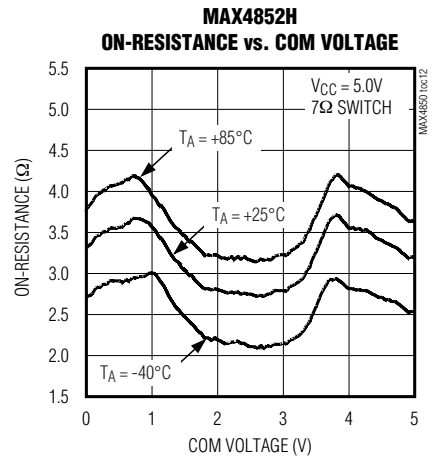
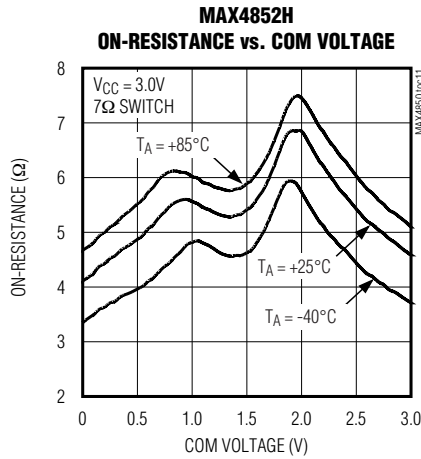
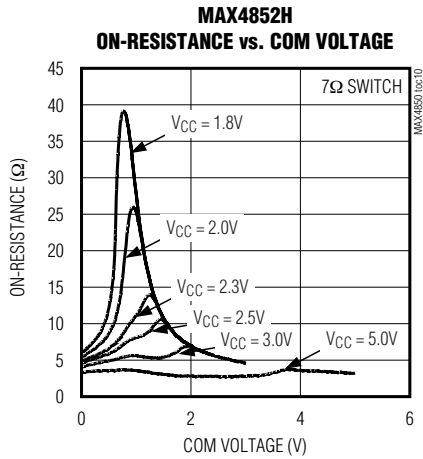

# Dual SPDT Analog Switches with Over-Rail Signal Handling

## Typical Operating Characteristics (continued)

( $V_{CC} = 3.0V$ ,  $T_A = +25^\circ C$ , unless otherwise noted.)

MAX4850/MAX4850H/MAX4852/MAX4852H

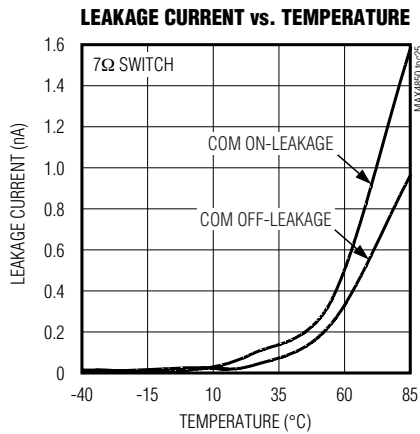
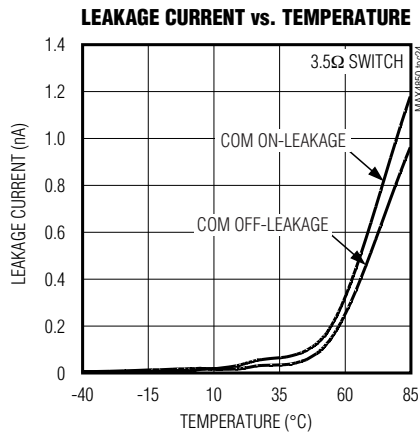
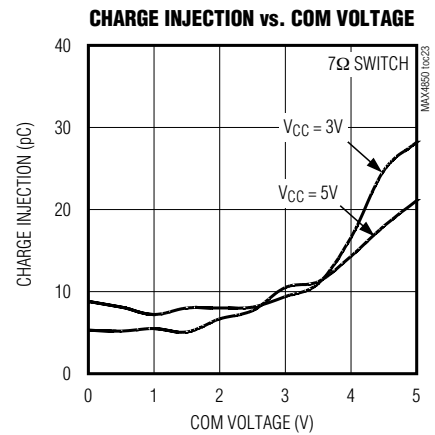
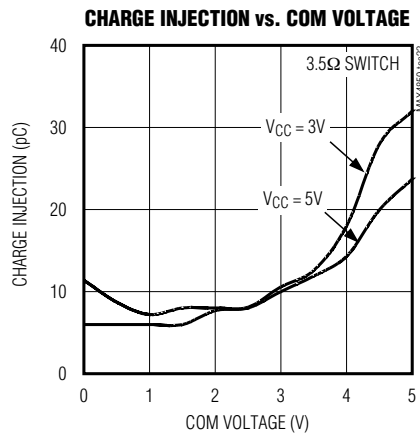
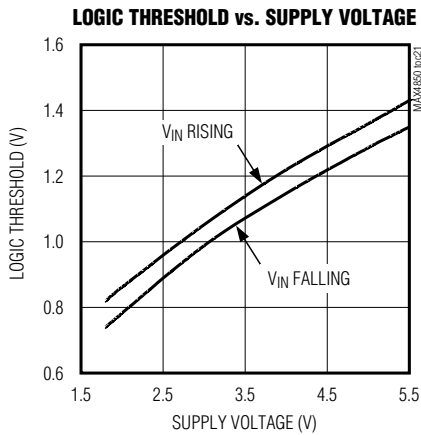
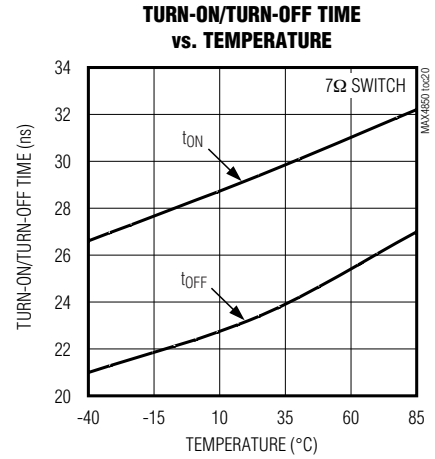
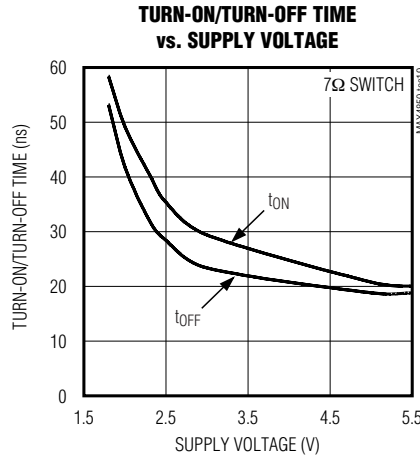
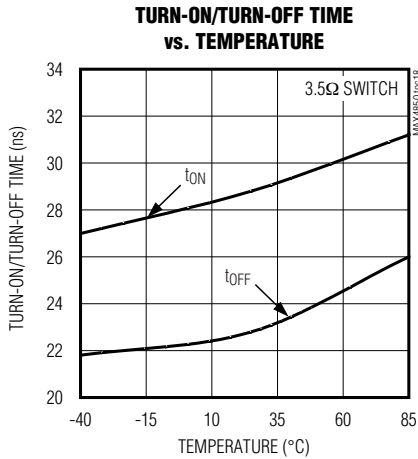

# Dual SPDT Analog Switches with Over-Rail Signal Handling

## Typical Operating Characteristics (continued)

(V<sub>CC</sub> = 3.0V, T<sub>A</sub> = +25°C, unless otherwise noted.)

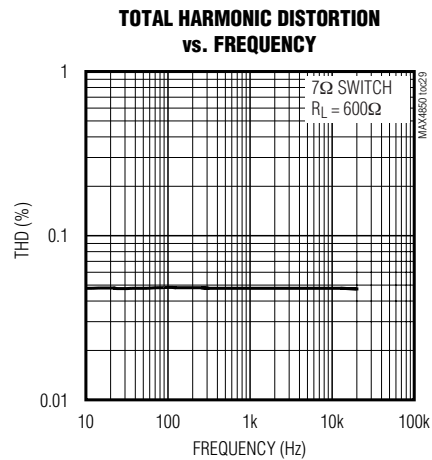
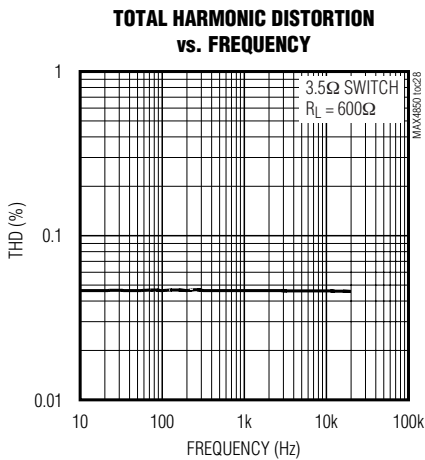
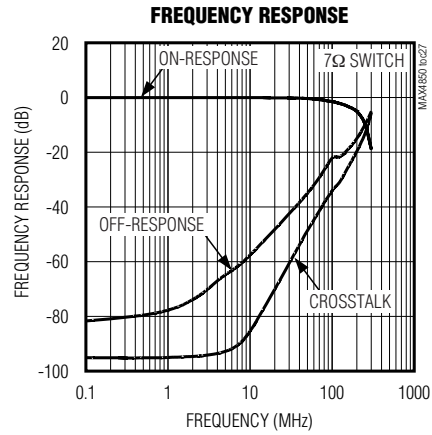
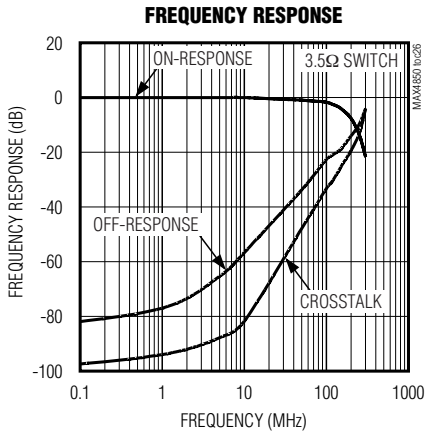



# Dual SPDT Analog Switches with Over-Rail Signal Handling

## Typical Operating Characteristics (continued)

( $V_{CC} = 3.0V$ ,  $T_A = +25^\circ C$ , unless otherwise noted.)

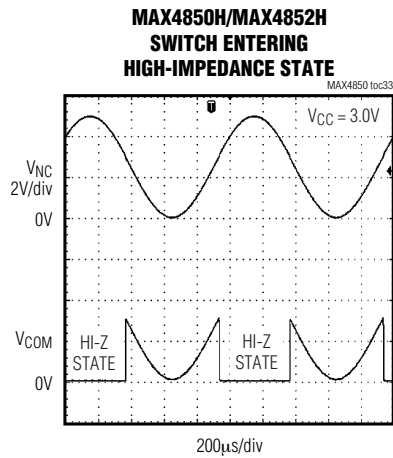
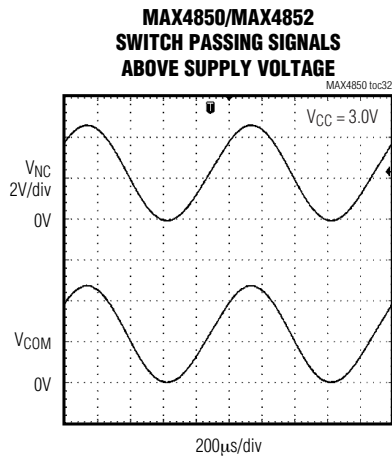
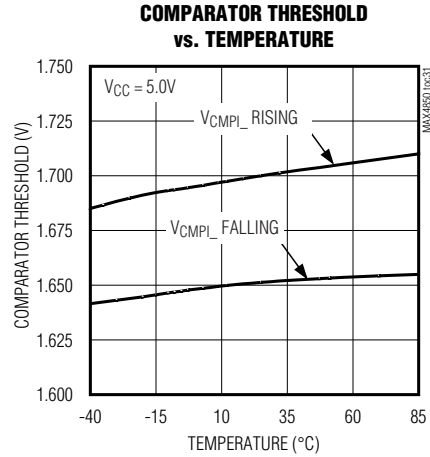
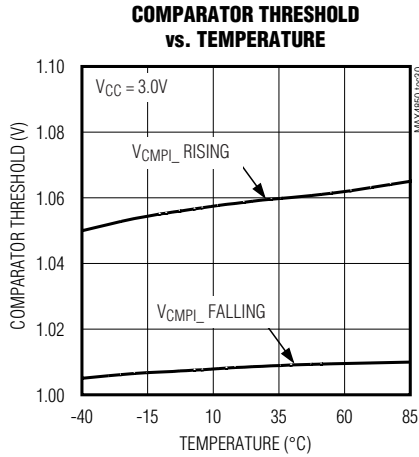

MAX4850/MAX4850H/MAX4852/MAX4852H

# Dual SPDT Analog Switches with Over-Rail Signal Handling

## Pin Descriptions

### MAX4850/MAX4850H

PIN	NAME	FUNCTION
1, 8	N.C.	No Connection. Not internally connected.
2	CIN1	Inverting Input for Comparator 1
3	CIN2	Inverting Input for Comparator 2
4	COM1	Common Terminal for Analog Switch 1
5	NO1	Normally Open Terminal for Analog Switch 1
6	GND	Ground
7	NC2	Normally Closed Terminal for Analog Switch 2
9	IN2	Digital Control Input for Analog Switch 2. A logic LOW on IN2 connects COM2 to NC2 and a logic HIGH connects COM2 to NO2.
10	COM2	Common Terminal for Analog Switch 2
11	COU1	Output for Comparator 1
12	NO2	Normally Open Terminal for Analog Switch 2
13	COU2	Output for Comparator 2
14	VCC	Supply Voltage. Bypass to GND with a 0.01 $\mu$ F capacitor as close to the pin as possible.
15	IN1	Digital Control Input for Analog Switch 1. A logic LOW on IN1 connects COM1 to NC1 and a logic HIGH connects COM1 to NO1.
16	NC1	Normally Closed Terminal for Analog Switch 1
EP	—	Exposed Paddle. Connect to PC board ground plane.

### MAX4852/MAX4852H

PIN	NAME	FUNCTION
1, 2, 3, 8, 11, 13	N.C.	No Connection. Not internally connected.
4	COM1	Common Terminal for Analog Switch 1
5	NO1	Normally Open Terminal for Analog Switch 1
6	GND	Ground
7	NC2	Normally Closed Terminal for Analog Switch 2
9	IN2	Digital Control Input for Analog Switch 2. A logic LOW on IN2 connects COM2 to NC2 and a logic HIGH connects COM2 to NO2.
10	COM2	Common Terminal for Analog Switch 2
12	NO2	Normally Open Terminal for Analog Switch 2
14	VCC	Supply Voltage. Bypass to GND with a 0.01 $\mu$ F capacitor as close to the pin as possible.
15	IN1	Digital Control Input for Analog Switch 1. A logic LOW on IN1 connects COM1 to NC1 and a logic HIGH connects COM1 to NO1.
16	NC1	Normally Closed Terminal for Analog Switch 1
EP	—	Exposed Paddle. Connect to PC board ground plane.

# Dual SPDT Analog Switches with Over-Rail Signal Handling

## Detailed Description

The MAX4850/MAX4850H/MAX4852/MAX4852H are low on-resistance, low-voltage, analog switches that operate from a +2V to +5.5V single supply and are fully specified for nominal 3.0V applications. These devices feature over-rail signal capability that allows signals up to 5.5V with supply voltages down to 2.0V. These devices are configured as dual SPDT switches.

These switches have low 50pF on-channel capacitance, which allows for 12Mbps switching of the data signals for USB 2.0 full speed/1.1 applications. The MAX485\_\_ are designed to switch D+ and D- USB signals with a guaranteed skew of less than 1ns (see Figure 1), as measured from 50% of the input signal to 50% of the output signal.

The MAX4850\_ features a comparator that can be used for headphone or mute detection. The comparator threshold is internally generated to be approximately 1/3 of  $V_{CC}$ .

## Applications Information

### Digital Control Inputs

The logic inputs (IN\_) accept up to +5.5V even if the supply voltages are below this level. For example, with a +3.3V  $V_{CC}$  supply, IN\_ can be driven low to GND and high to +5.5V, allowing for mixing of logic levels in a system. Driving IN\_ rail-to-rail minimizes power con-

sumption. For a +2V supply voltage, the logic thresholds are 0.5V (low) and 1.4V (high); for a +5V supply voltage, the logic thresholds are 0.8V (low) and 1.8V (high).

### Analog Signal Levels

The on-resistance of these switches changes very little for analog input signals across the entire supply voltage range (see *Typical Operating Characteristics*). The switches are bidirectional, so NO\_, NC\_, and COM\_ can be either inputs or outputs.

### Comparator

The positive terminal of the comparator is internally set to  $V_{CC}/3$ . When the negative terminal (CIN\_) is below the threshold ( $V_{CC}/3$ ), the comparator output (COUT\_) goes high. When CIN\_ rises above  $V_{CC}/3$ , COUT\_ goes low.

The comparator threshold allows for detection of headphones since headphone audio signals are typically biased to  $V_{CC}/2$ .

### Power-Supply Sequencing

**Caution:** Do not exceed the absolute maximum ratings because stresses beyond the listed ratings may cause permanent damage to the device.

Proper power-supply sequencing is recommended for all CMOS devices. Always apply  $V_{CC}$  before applying analog signals, especially if the analog signal is not current-limited.

MAX4850/MAX4850H/MAX4852/MAX4852H

# Dual SPDT Analog Switches with Over-Rail Signal Handling

## Test Circuits/Timing Diagrams

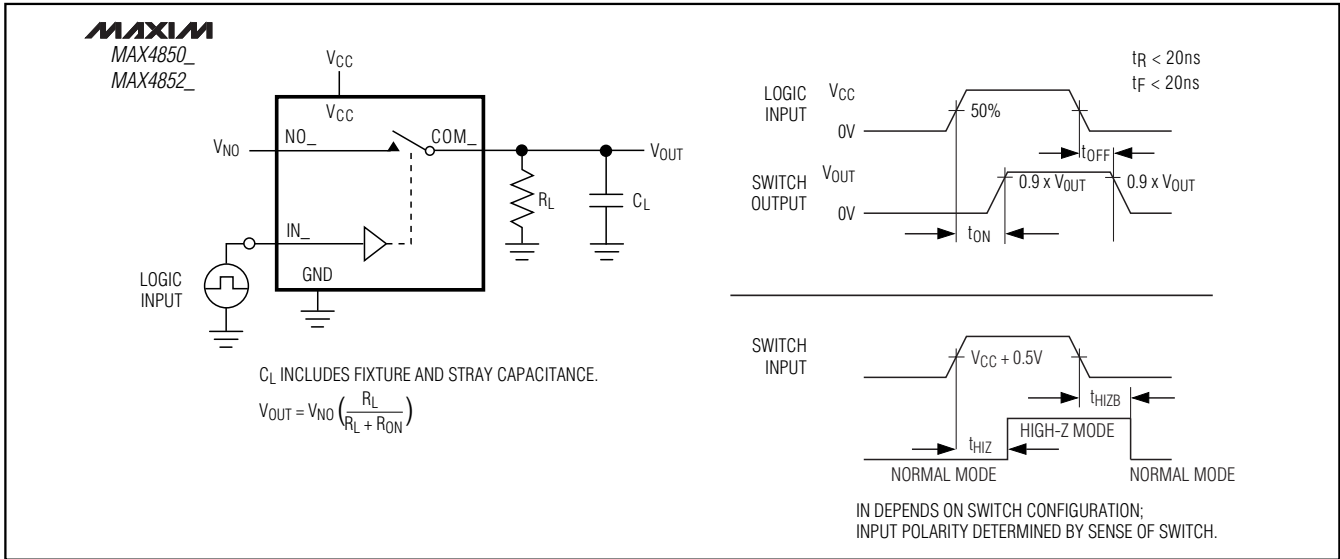

Figure 1. Switching Time

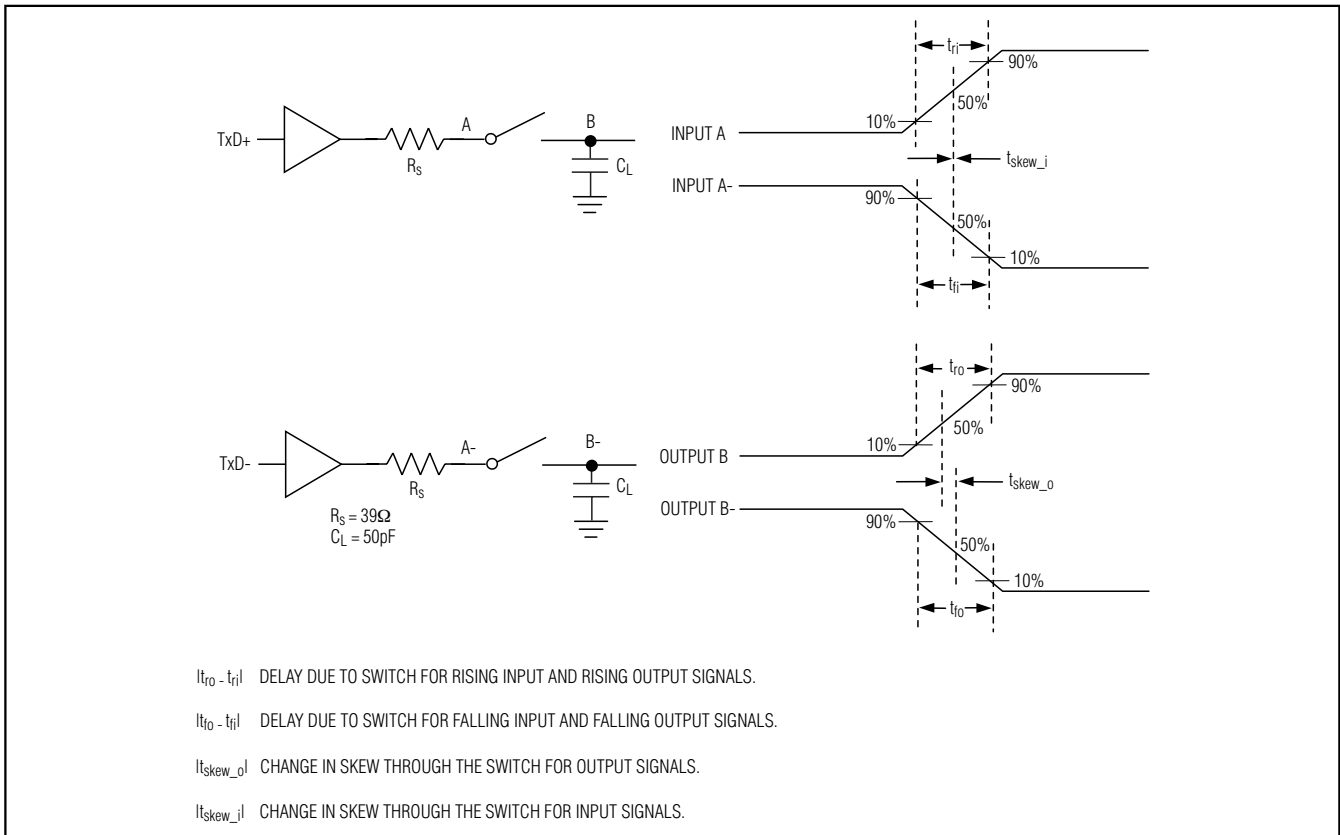

Figure 2. Input/Output Skew Timing Diagram



# Dual SPDT Analog Switches with Over-Rail Signal Handling

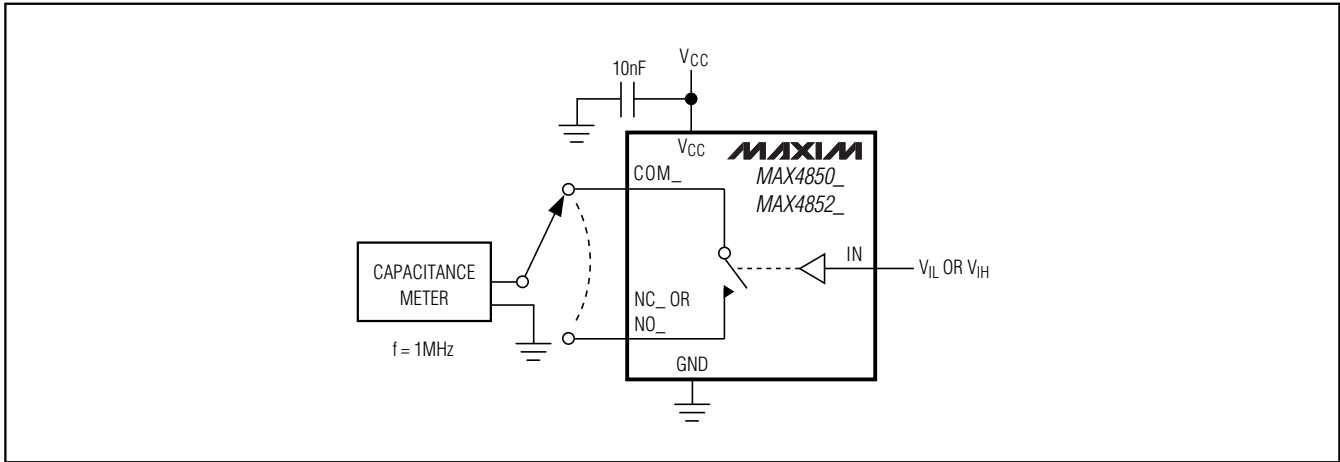

Figure 6. Channel Off-/On-Capacitance

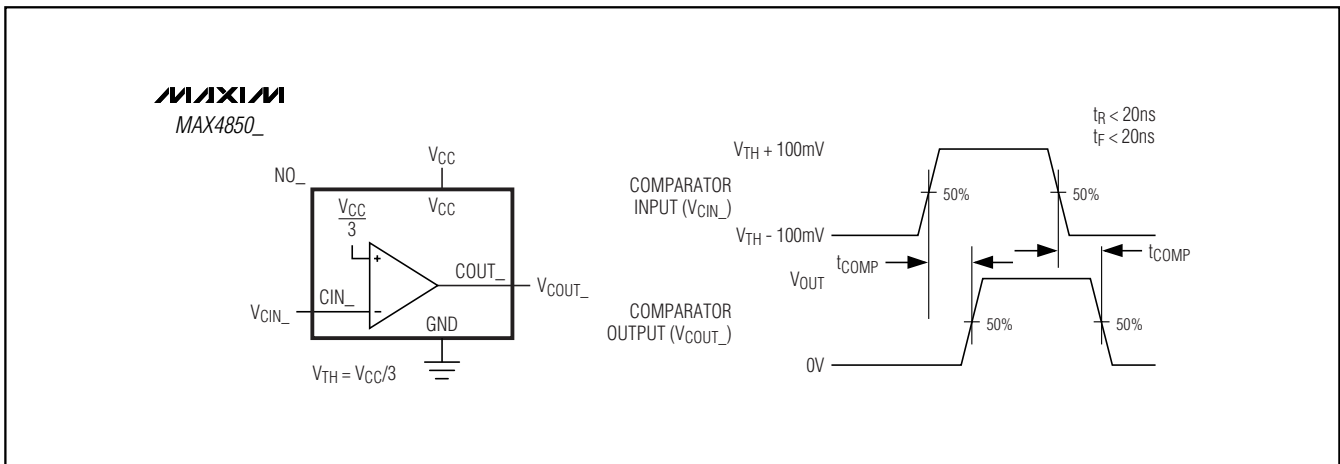
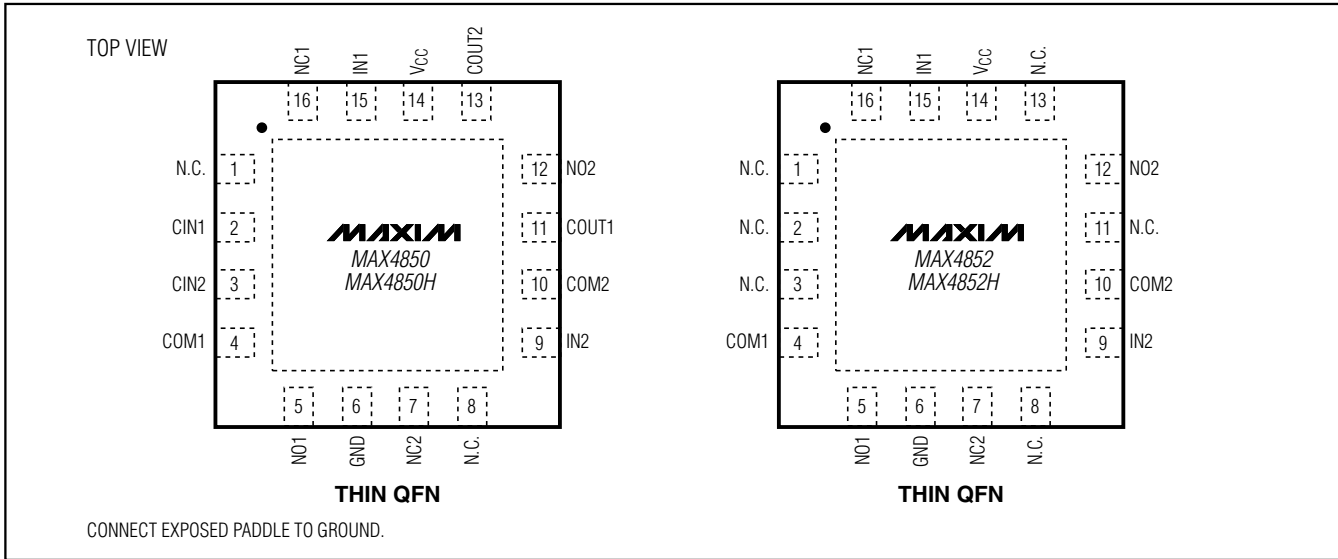

Figure 7. Comparator Switching Time

# Dual SPDT Analog Switches with Over-Rail Signal Handling

## Pin Configurations



## Selector Guide

PART	R <sub>ON</sub> NC_/NO_ (Ω)	COMPARATORS	OVER-RAIL HANDLING
MAX4850	3.5/3.5	2	Input signal passes through the switch
MAX4850H	3.5/3.5	2	High-impedance switch input
MAX4852	3.5/7	—	Input signal passes through the switch
MAX4852H	3.5/7	—	High-impedance switch input

## Chip Information

TRANSISTOR COUNT: 735  
PROCESS: CMOS

## Typical Operating Circuit

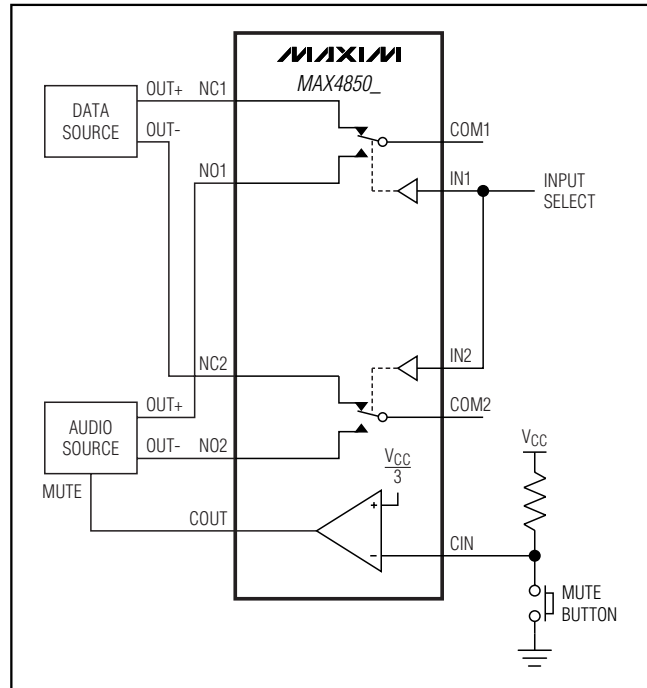

MAX4850/MAX4850H/MAX4852/MAX4852H

# Dual SPDT Analog Switches with Over-Rail Signal Handling

## Package Information

(The package drawing(s) in this data sheet may not reflect the most current specifications. For the latest package outline information go to [www.maxim-ic.com/packages](http://www.maxim-ic.com/packages).)

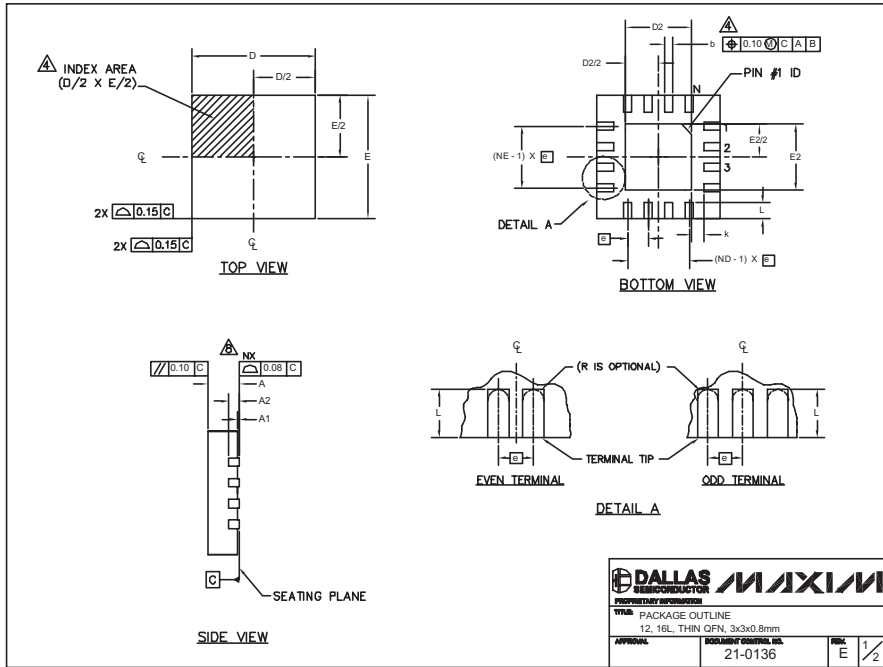

PKG	12L 3x3			16L 3x3		
REF.	MIN.	NOM.	MAX.	MIN.	NOM.	MAX.
A	0.70	0.75	0.80	0.70	0.75	0.80
b	0.20	0.25	0.30	0.20	0.25	0.30
D	2.90	3.00	3.10	2.90	3.00	3.10
E	2.90	3.00	3.10	2.90	3.00	3.10
e	0.50 BSC.			0.50 BSC.		
L	0.45	0.55	0.65	0.30	0.40	0.50
N	12			16		
ND	3			4		
NE	3			4		
A1	0	0.02	0.05	0	0.02	0.05
A2	0.20 REF			0.20 REF		
k	0.25	-	-	0.25	-	-

PKG CODES	D2			E2			PIN ID	JEDEC	DOWN BONDS ALLOWED
	MIN.	NOM.	MAX.	MIN.	NOM.	MAX.			
T1233-1	0.95	1.10	1.25	0.95	1.10	1.25	0.35 x 45°	WEED-1	NO
T1233-3	0.95	1.10	1.25	0.95	1.10	1.25	0.35 x 45°	WEED-1	YES
T1633-1	0.95	1.10	1.25	0.95	1.10	1.25	0.35 x 45°	WEED-2	NO
T1633-2	0.95	1.10	1.25	0.95	1.10	1.25	0.35 x 45°	WEED-2	YES
T1633F-3	0.85	0.80	0.85	0.85	0.80	0.85	0.225 x 45°	WEED-2	N/A
T1633-4	0.95	1.10	1.25	0.95	1.10	1.25	0.35 x 45°	WEED-2	NO

NOTES:

- DIMENSIONING & TOLERANCING CONFORM TO ASME Y14.5M-1994.
- ALL DIMENSIONS ARE IN MILLIMETERS. ANGLES ARE IN DEGREES.
- N IS THE TOTAL NUMBER OF TERMINALS.
- THE TERMINAL #1 IDENTIFIER AND TERMINAL NUMBERING CONVENTION SHALL CONFORM TO JEDEC 95-1 SPP-012. DETAILS OF TERMINAL #1 IDENTIFIER ARE OPTIONAL, BUT MUST BE LOCATED WITHIN THE ZONE INDICATED. THE TERMINAL #1 IDENTIFIER MAY BE EITHER A MOLD OR MARKED FEATURE.
- DIMENSION b APPLIES TO METALLIZED TERMINAL AND IS MEASURED BETWEEN 0.20 mm AND 0.25 mm FROM TERMINAL TIP.
- ND AND NE REFER TO THE NUMBER OF TERMINALS ON EACH D AND E SIDE RESPECTIVELY.
- DEPOPULATION IS POSSIBLE IN A SYMMETRICAL FASHION.
- COPLANARITY APPLIES TO THE EXPOSED HEAT SINK SLUG AS WELL AS THE TERMINALS.
- DRAWING CONFORMS TO JEDEC MO220 REVISION C.

Maxim cannot assume responsibility for use of any circuitry other than circuitry entirely embodied in a Maxim product. No circuit patent licenses are implied. Maxim reserves the right to change the circuitry and specifications without notice at any time.

16 **Maxim Integrated Products, 120 San Gabriel Drive, Sunnyvale, CA 94086 408-737-7600**



SITE  
SEARCHPART NO.  
SEARCH

WHAT'S NEW

PRODUCTS

SOLUTIONS

DESIGN

APPNOTES

SUPPORT

BUY

COMPANY

MEMBERS

## MAX4852

### Part Number Table

#### Notes:

1. See the [MAX4852 QuickView Data Sheet](#) for further information on this product family or download the [MAX4852 full data sheet](#) (PDF, 648kB).
2. Other options and links for purchasing parts are listed at: <http://www.maxim-ic.com/sales>.
3. [Didn't Find What You Need?](#) Ask our applications engineers. Expert assistance in finding parts, usually within one business day.
4. Part number suffixes: T or T&R = tape and reel; + = RoHS/lead-free; # = RoHS/lead-exempt. More: See [full data sheet](#) or [Part Naming Conventions](#).
5. \* Some packages have variations, listed on the drawing. "PkgCode/Variation" tells which variation the product uses.

Part Number	Free Sample	Buy Direct	Package: TYPE PINS SIZE DRAWING CODE/VAR *	Temp	RoHS/Lead-Free? Materials Analysis
MAX4852ETE+	<input type="checkbox"/>	<input type="checkbox"/>	THIN QFN;16 pin;3X3X0.8mm Dwg: <a href="#">21-0136I</a> (PDF) Use pkgcode/variation: T1633+4*	-40C to +85C	RoHS/Lead-Free: <a href="#">Yes</a> <a href="#">Materials Analysis</a>
MAX4852ETE+T	<input type="checkbox"/>	<input type="checkbox"/>		-40C to +85C	RoHS/Lead-Free: <a href="#">Yes</a>
MAX4852ETE	<input type="checkbox"/>	<input type="checkbox"/>	THIN QFN;16 pin;3X3X0.8mm Dwg: <a href="#">21-0136I</a> (PDF) Use pkgcode/variation: T1633-4*	-40C to +85C	RoHS/Lead-Free: <a href="#">No</a> <a href="#">Materials Analysis</a>
MAX4852ETE-T	<input type="checkbox"/>	<input type="checkbox"/>		-40C to +85C	RoHS/Lead-Free: <a href="#">No</a>

[Didn't Find What You Need?](#)[CONTACT US: SEND US AN EMAIL](#)